

SFMC28-461 EMI Input Filters

28 VOLT INPUT – 2.7 AMP

Features

- Fully qualified to Class H or K
- Passive components used for maximum tolerance in space environments
- -55°C to +125°C operation
- Nominal 28 V input, 0 V to 50 V operation
- Up to 2.7 A throughput current
- 60 dB attenuation typical at 500KHz
- Compliant to MIL-STD-461C CE-03
- Compatible with MIL-STD-704 A-E 28 VDC power bus



| INPUT VOLTAGE AND CURRENT | |
|---------------------------|-------------|
| Input (V) | Current (A) |
| 28 | 2.7 |

DESCRIPTION

The SFMC28-461™ EMI filters provide an off-the-shelf filtering solution compliant to MIL-PRF-38534, Class H or Class K, for use in your space system. SFMC28-461 filters reduce the input line reflected ripple current of our switching DC/DC converters. Use an SFMC28-461 filter with our SMTR, SMHF and SMSA series of DC/DC converters to meet MIL-STD-461C levels of conducted emission (CE01, CE03). The SFMC filters are designed exclusively with passive components providing maximum tolerance for space environments.

SCREENING

The SFMC28-461 EMI filters offer environmental screening levels to Space Prototype (O), Class H, or Class K requirements. Radiation tolerant to Radiation Hardness Assurance (RHA) levels of “-” (O) or “H”, per MIL-STD-38534. Interpoint model numbers use an “O” in the RHA designator position to indicate the “-” (dash) Radiation Hardness Assurance level of MIL-PRF-38534, which is defined as “no RHA”. See “Class H and K, MIL-PRF-38534 Screening” tables for more information.

RIPPLE REDUCTION

The SFMC28-461 EMI filter, when used with Interpoint’s converters, reduces reflected input ripple current by a minimum of 55 dB at 500 kHz and 60 dB at 1 MHz. The filter and converter combination performance exceeds the CEO3 requirements of MIL-STD-461C.

INSERTION LOSS

The maximum DC insertion loss for the SFMC28-461 filter (at a load of 22 watts) represents a power loss of less than 2%.

FILTER DESIGN

SFMC28-461 filters incorporate thick-film hybrid technology and use only high quality ceramic capacitors for reliable high temperature operation.

Derating according to the requirements of MIL-STD-975 assures dependable performance in the harsh environments of space. Compliance to MIL-STD-975 derating is achieved at or below case operating temperatures of 90°C.

All SFMC28-461 filters are built to the same assembly drawing regardless of environmental screening or radiation tolerance level. Filters designated level OO, indicating standard environmental screening, are electrically comparable to filters designated level KH, the highest environmental screening level. This ensures consistency between your prototype or test system using level OO filters and your flight system using filters with higher levels of environmental screening and radiation tolerance. Element evaluation (screening at the component level) of Class H or Class K filters ensures even greater reliability. Refer to Table 1, 2, and 3 for more information.

OPERATING TEMPERATURE

The filter operates at full load over the temperature range of -55°C to +125°C case. Above +125°C, the current must be derated as specified on page two.

PACKAGING FOR SPACE

SFMC28-461 EMI filters are encased in high-reliability, hermetically-sealed metal packages and weigh just 48 grams. A small footprint of 2.110 Inches (53.59 mm) by 1.115 inches (28.32 mm) by 0.400 inches (10.16 mm) minimizes the board area needed for the filter. Cover marking inks are NASA approved to Total Mass Loss (TML) and Collected Volatile Condensable Material (CVCM) outgassing requirements for operation in space environments.

SFMC28-461 EMI Input Filters

28 VOLT INPUT – 2.7 AMP

OPERATING CONDITIONS AND CHARACTERISTICS

Input Voltage Range

- 0 to 50 VDC continuous

Lead Soldering Temperature (10 sec per pin)

- 300°C

Storage Temperature Range (Case)

- -65°C to +150°C

Case Operating Temperature (Tc)

- -55°C to +125°C full power

Derating Output Power/Current

- Derate linearly from 100% at 125°C to 0% at 135°C case

Input to Output Capacitance

- 0.048 μF max., any pin to case

Isolation

- 100 megohm minimum at 500 VDC
- Any pin to case, except case pin

MECHANICAL AND ENVIRONMENTAL

Size (maximum)

Non-flanged

2.125 x 1.125 x 0.400 (53.98 x 28.58 x 10.16 mm)

See case H1 for dimensions.

Flanged

2.910 x 1.125 x 0.400 inches (73.91 x 28.58 x 10.16 mm)

See case K2 for dimensions.

Weight (maximum)

48 grams typical

Screening

Space Prototype (O), Class H, or Class K

Radiation tolerant to Radiation Hardness Assurance (RHA) levels of “-” (O) or “H”, per MIL-STD-38534. Interpoint model numbers use an “O” in the RHA designator position to indicate the “-” (dash) Radiation Hardness Assurance level of MIL-PRF-38534, which is defined as “no RHA”.

See “Class H and K, MIL-PRF-38534 Screening” tables for more information. Available configurations: OO, HH, KH

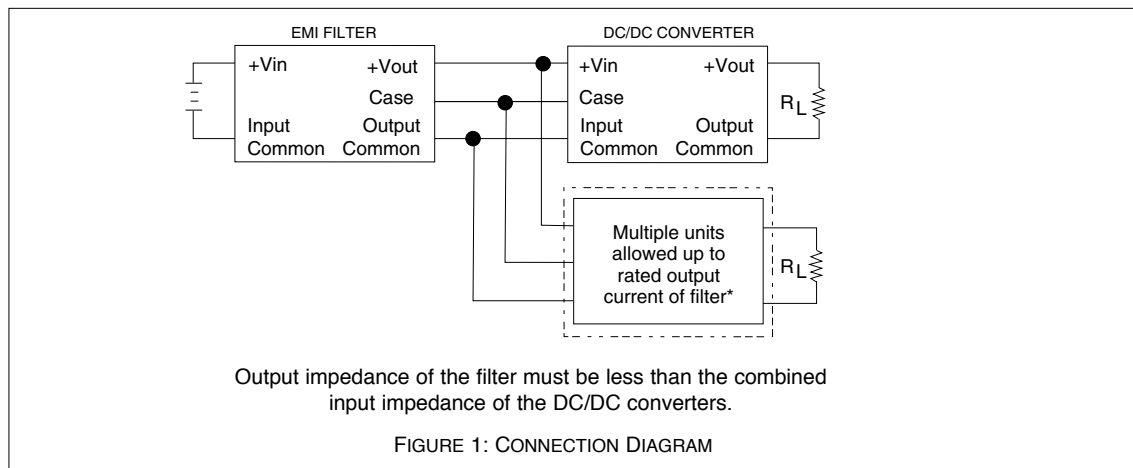

SFMC28-461 EMI Input Filters

28 VOLT INPUT – 2.7 AMP

PIN OUT

| Pin | Designation |
|-----|-----------------|
| 1 | Positive Input |
| 2 | Positive Output |
| 3 | Case Ground |
| 4 | Output Common |
| 5 | Input Common |

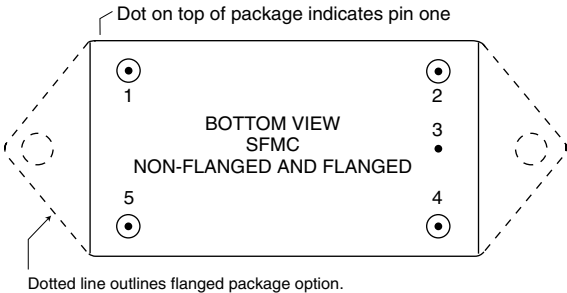

See cases H1 and K2 for dimensions.

FIGURE 2: PIN OUT

SFMC28-461 EMI Input Filters

28 VOLT INPUT – 2.7 AMP

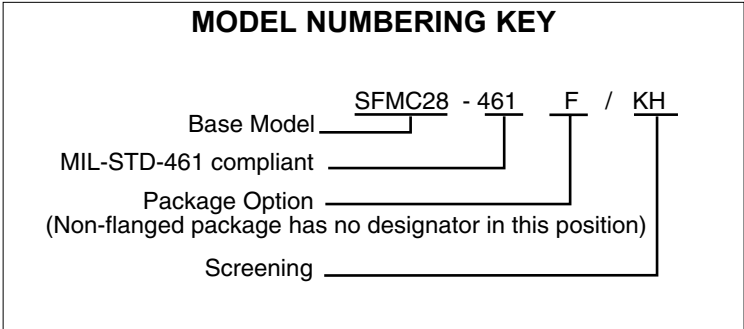

DSCC NUMBER

| DSCC Drawing (5915) | SFMC28-461 Filter Similar Part |
|---------------------|--------------------------------|
| 94010H02HXC | SFMC28-461/HH |
| 94010H02HXC | SFMC28-461f/HH |
| 94010H02KXC | SFMC28-461/KH |
| 94010H02KZC | SFMC28-461/KH |

Flanged SMDs have the suffix HZC in place of HXC.

Interpoint's DSCC drawing models are similar in performance and dimensions to standard models, however, slight differences in specifications may exist. Refer to the DSCC drawing for the exact specifications. DSCC drawings can be downloaded from:
<http://www.dsccols.com/programs/smcr>

MODEL SELECTION

SFMC28- 461 _____ / _____
Base model *MIL-STD-461 compliant* *case option* *screening*

Choose one from each of the following rows:

Case option non-flanged, leave blank F - flanged
Screening OO* - Space prototype, HH, KH

*Interpoint model numbers use an "O" in the RHA designator position to indicate the "-" (dash) Radiation Hardness Assurance level of MIL-PRF-38534, which is defined as "no RHA"

SFMC28-461 EMI Input Filters

28 VOLT INPUT – 2.7 AMP

Electrical Characteristics: 25°C Tc, nominal Vin, unless otherwise specified.

| PARAMETER | CONDITIONS | SFMC28-461 | | | UNITS |
|--------------------------------------|--------------------------|-------------------------------------|-----|------|-------|
| | | MIN | TYP | MAX | |
| INPUT VOLTAGE | CONTINUOUS | 0 | 28 | 50 | VDC |
| INPUT CURRENT | | – | – | 2.7 | A |
| NOISE REJECTION | 500 kHz | 55 | – | – | dB |
| | 1 MHz | 60 | – | – | |
| | 5 MHz | 60 | – | – | |
| DC RESISTANCE (R _{DC}) | TC = 25°C | – | – | 0.20 | Ω |
| OUTPUT VOLTAGE ¹ | STEADY STATE | $V_{OUT} = V_{IN} - I_{IN}(R_{DC})$ | | | VDC |
| OUTPUT CURRENT | STEADY STATE | – | – | 2.7 | A |
| REFLECTED RIPPLE CURRENT | FROM CONVERTER TO FILTER | – | – | 1.0 | A |
| POWER DISSIPATION AT MAXIMUM CURRENT | | – | – | 1.5 | W |

Notes

1. Typical applications result in Vout within 2% of Vin.

SFMC28-461 EMI Input Filters

28 VOLT INPUT – 2.7 AMP

Typical Performance Curves: 25°C Tc , nominal Vin, unless otherwise specified.

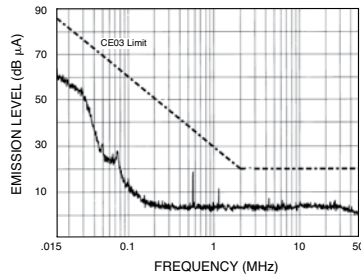

DC/DC Converter Typical Worst Case
EMI With SFMC-461 Filter
FIGURE 3

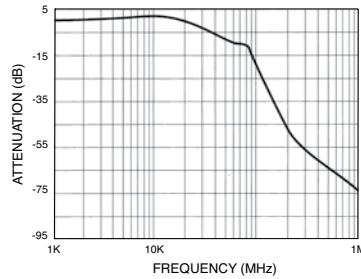

SFMC-461 Typical Amplitude
Response vs. Frequency
FIGURE 4

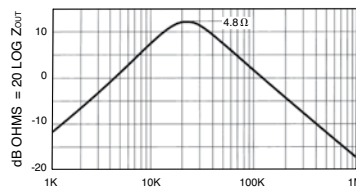

Typical Output Impedance (Z)
With Input Shorted
FIGURE 5

SFMC28-461 EMI Input Filter Cases

28 VOLT INPUT – 2.7 AMP

BOTTOM VIEW CASE H1

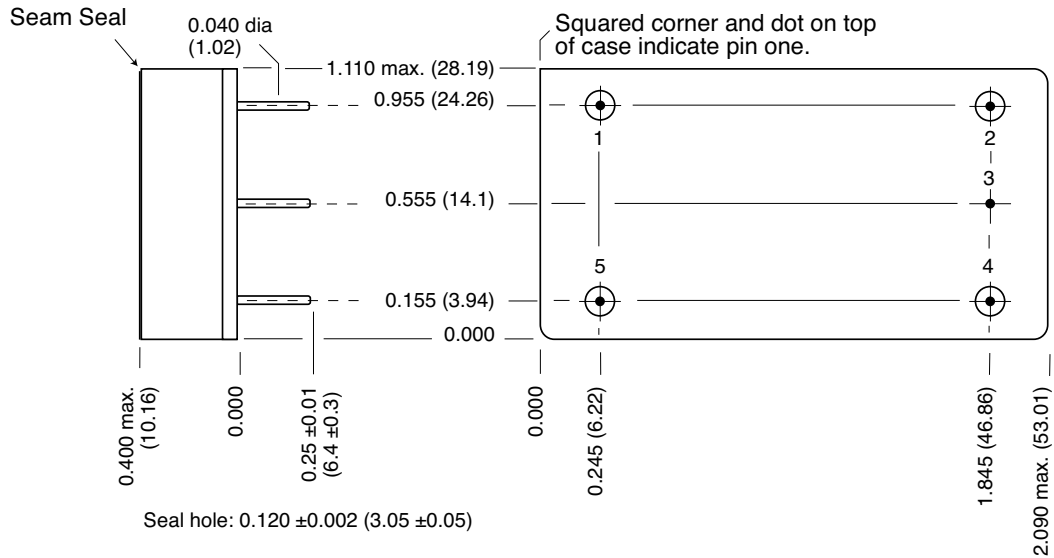

Case dimensions in inches (mm)

Tolerance ± 0.005 (0.13) for three decimal places
 ± 0.01 (0.3) for two decimal places
 unless otherwise specified

CAUTION

Heat from reflow or wave soldering may damage the device.
 Solder pins individually with heat application not exceeding 300°C for 10 seconds per pin.

Materials

Header Cold Rolled Steel/Nickel/Gold
 Cover Kovar/Nickel
 Pins #52 alloy/Gold ceramic seal

Case H1, Rev C, 20060110

Please refer to the numerical dimensions for accuracy. All information is believed to be accurate, but no responsibility is assumed for errors or omissions. Interpoint reserves the right to make changes in products or specifications without notice.

Copyright © 1999-2006 Interpoint Corp. All rights reserved.

FIGURE 6: CASE H1

SFMC28-461 EMI Input Filter Cases

28 VOLT INPUT – 2.7 AMP

BOTTOM VIEW CASE K2

Flanged cases: Designator "F" required in Case Option position of model number.

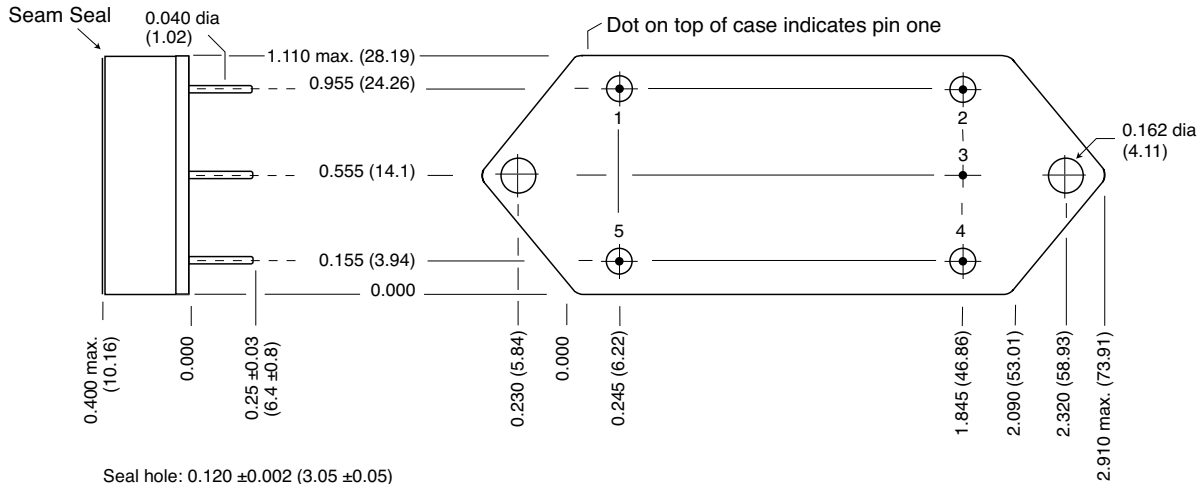

Case dimensions in inches (mm)
 Tolerance ±0.005 (0.13) for three decimal places
 ±0.01 (0.3) for two decimal places
 unless otherwise specified

CAUTION

Heat from reflow or wave soldering may damage the device.
 Solder pins individually with heat application not exceeding 300°C for 10 seconds per pin.

Materials

Header Cold Rolled Steel/Nickel/Gold
 Cover Kovar/Nickel
 Pins #52 alloy/Gold ceramic seal

Case K2, Rev C, 20060110

Please refer to the numerical dimensions for accuracy. All information is believed to be accurate, but no responsibility is assumed for errors or omissions. Interpoint reserves the right to make changes in products or specifications without notice.

Copyright © 1999-2006 Interpoint Corp. All rights reserved.

FIGURE 7: CASE K1

SFMC28-461 EMI Input Filters

28 VOLT INPUT – 2.7 AMP

CLASS H AND K, MIL-PRF-38534 ELEMENT EVALUATION

| TEST PERFORMED (COMPONENT LEVEL) | SPACE PROTOTYPE O NON-QML ¹ | | CLASS H QML | | CLASS K QML | |
|---|--|----------------|------------------|----------------|------------------|----------------|
| | M/S ² | P ³ | M/S ² | P ³ | M/S ² | P ³ |
| | Element Electrical | yes | no | yes | yes | yes |
| Element Visual | no | no | yes | yes | yes | yes |
| Internal Visual | no | N/A | yes | N/A | yes | N/A |
| Temperature Cycling | no | no | no | no | yes | yes |
| Constant Acceleration | no | no | no | no | yes | yes |
| Interim Electrical | no | N/A | no | N/A | yes | N/A |
| Burn-in | no | N/A | no | N/A | yes | N/A |
| Post Burn-in Electrical | no | N/A | no | N/A | yes | N/A |
| Steady State Life | no | N/A | no | N/A | yes | N/A |
| Voltage Conditioning Aging | N/A | no | N/A | no | N/A | yes |
| Visual Inspection | no | no | N/A | no | N/A | yes |
| Final Electrical | no | no | yes | yes | yes | yes |
| Wire Bond Evaluation ⁴ | no | no | yes | yes | yes | yes |
| SEM | no | N/A | no | N/A | yes | N/A |
| SLAM™/C-SAM: Input capacitors only (Add'l test, not req. by H or K) | no | no | no | yes | no | yes |

Notes:

1. Non-QML products do not meet all of the requirements of MIL-PRF-38534.
2. M/S = Active components (Microcircuit and Semiconductor Die)
3. P = Passive components
4. Not applicable to EMI filters that have no wirebonds.

Definitions:

Element Evaluation: Component testing/screening per MIL-STD-883 as determined by MIL-PRF-38534
SEM: Scanning Electron Microscopy
SLAM™: Scanning Laser Acoustic Microscopy
C-SAM: C - Mode Scanning Acoustic Microscopy

SFMC28-461 EMI Input Filters

28 VOLT INPUT – 2.7 AMP

CLASS H AND K, MIL-PRF-38534 ENVIRONMENTAL SCREENING

| TEST PERFORMED (END ITEM LEVEL) | SPACE PROTOTYPE O NON-QML ¹ | CLASS H, QML | CLASS K, QML |
|--|--|------------------|------------------|
| Non-destruct bond pull ² Method 2023 | no | yes ³ | yes |
| Pre-cap Inspection Method 2017, 2032 | yes | yes | yes |
| Temperature Cycle (10 times) Method 1010, Cond. C, -65°C to 150°C, ambient | yes | yes | yes |
| Constant Acceleration Method 2001, 3000 g | yes | yes | yes |
| PIND Test Method 2020, Cond. A | no | yes ³ | yes |
| Pre burn-in test | yes | yes | yes |
| Burn-in Method 1015, 125°C case, typical | | | |
| 96 hours | yes | no | no |
| 160 hours | no | yes | no |
| 2 x 160 hour (includes mid BI test) | no | no | yes |
| Final electrical test MIL-PRF-38534 Group A, Subgroups 1 through 6 -55°C, +25°C, +125°C case | yes | yes | yes |
| Radiography Method 2012 | N/A | N/A | yes |
| Post Radiography Electrical Test Room temperature | N/A | N/A | yes ³ |
| Hermeticity test Fine Leak, Method 1014, Cond. A | yes | yes | yes |
| Gross Leak, Method 1014, Cond. C | yes | yes | yes |
| Final visual inspection Method 2009 | yes | yes | yes |

Test methods are referenced to MIL-STD-883 as determined by MIL-PRF-38534.

Notes:

1. Space Prototype (O), non-QML products, do not meet all of the requirements of MIL-PRF-38534.
2. Not applicable to EMI filters that have no wirebonds.
3. Not required by DSCC but performed to assure product quality.

SFMC28-461 EMI Input Filters

28 VOLT INPUT – 2.7 AMP

CLASS H AND K, MIL-PRF-38534 RADIATION ASSURANCE

| PRODUCT LEVEL AVAILABILITY | ENVIRONMENTAL SCREENING LEVELS | | |
|--|--|-----------------|-----------------|
| | SPACE PROTOTYPE O NON-QML ³ | CLASS H QML | CLASS K QML |
| RADIATION HARDNESS ASSURANCE LEVELS | | | |
| O² : Standard, no radiation guarantee | OO | HO | N/A |
| H^{1, 5} : Radiation tolerant – Tested lots Up to 1,000 K Rads (Si) total dose | N/A | HH ⁴ | KH ⁴ |

Notes:

- Our EMI filters are designed exclusively with passive components providing maximum tolerance for space environment requirements.
- Interpoint model numbers use an "O" in the RHA designator position to indicate the "-" (dash) Radiation Hardness Assurance level of MIL-PRF-38534, which is defined as "no RHA".
- Space Prototype (O), non-QML products, do not meet all of the requirements of MIL-PRF-38534.
- Redmond site, Interpoint, has a Radiation Hardness assurance plan on file with DSCC. Our SMD products with RHA "H" code meet DSCC requirements.
- Space filters are only available with Radiation Hardness Assurance (RHA) levels of "O" and "H".