

FMCE-0328 EMI Input Filter

28 VOLT INPUT – 3 AMP

FEATURES

Attenuation to 60 dB at 500 kHz, typical

- Operating temperature -55° to +125°C
- Nominal 28 V input, -0.5 to 50 V operation
- Transient rating -0.5 to 80 V for 1 second
- Up to 3 A throughput current over the full input voltage range of -0.5 to 50 V
- Compliant to
 - MIL-STD-461C CE03
 - MIL-STD-461D, E and F CE102
 - MIL-STD-461C CS01
 - MIL-STD-461D, E and F CS101
- Compatible with MIL-STD-704 A-E 28 VDC power bus



INPUT VOLTAGE AND CURRENT	
Input (V)	Current (A)
28	3

DESCRIPTION

Interpoint specifically designed the FMCE-0328™ EMI filter to reduce the input line reflected ripple current of the following high frequency DC/DC converters: MTR, MHF+ and MHV Series converters. These filters are intended for use in 28 volt applications which must meet MIL-STD-461C CE03 and CS01 and/or MIL-STD-461D, E and F CE102 and CS101 levels of conducted emissions. At 50 VDC input (high line), the filter provides 150 watts of throughput power.

The FMCE-0328 filters are built using thick-film hybrid technology and are hermetically sealed in metal packages for military, aerospace, and other high-reliability applications. Only ceramic capacitors are used in the filters to ensure reliable high temperature operation.

The filters are offered with standard screening, “ES” screening, or fully compliant to “883” MIL-PRF-38534 Class H screening. Standard microcircuit drawings (SMD) are available.

MIL-STD NOISE MANAGEMENT

When used in conjunction with Interpoint converters, the FMCE-0328 filters reduce input ripple current within the frequency band of 100 kHz to 50 MHz. When used with an Interpoint converter, performance exceeds the CE03 test of MIL-STD-461C and meets the requirements of CS01 of MIL-STD-461C. These filters also meet CE102 and CS101 of MIL-STD-461D, E and F.

OPERATING TEMPERATURE

The filters are rated to operate, with no degradation of performance, over the temperature range of -55°C to +125°C (as measured at the baseplate). Above +125°C, current must be derated as specified on the following page.

INSERTION LOSS

Low DC resistance design results in a maximum power loss of less than 2% with typical input voltage.

FMCE-0328 EMI Input Filter

28 VOLT INPUT – 3 AMP

OPERATING CONDITIONS AND CHARACTERISTICS

Input Voltage Range

- Continuous -0.5 to 50 VDC
- Transient -0.5 to 80 V for 1 second

Lead Soldering Temperature (10 sec per pin)

- 300°C

Storage Temperature Range (Case)

- -65°C to +150°C

Case Operating Temperature (T_C)

- -55°C to +125°C full power

Derating Output Power/Current

- Linearly from 100% at 125°C to 80% at 135°C case

Input to Output Capacitance ($T_C = 25^\circ\text{C}$)

- 0.024 μF max, any pin to case

Isolation ($T_C = 25^\circ\text{C}$)

- 100 megohm minimum at 500 V
- Any pin to case, except case pin

Electrostatic Discharge (ESD) Sensitivity per MIL-PRF-38534

- Classification 3B, 8000 V

MECHANICAL AND ENVIRONMENTAL

Size (maximum)

- Non-flanged, case E3
 - 1.460 x 1.130 x 0.330 (37.08 x 28.70 x 8.38 mm)
- Flanged, case G3
 - 2.005 x 1.130 x 0.330 inches (50.93 x 28.70 x 8.38 mm)
 - See cases E3 and G3 for dimensions

Weight (maximum)

- 32 grams

Screening

The FMCE-0328 EMI Input filter offers Standard, /ES or 883, Class H, QML screening. See Screening Tables 1 and 2 for more information.

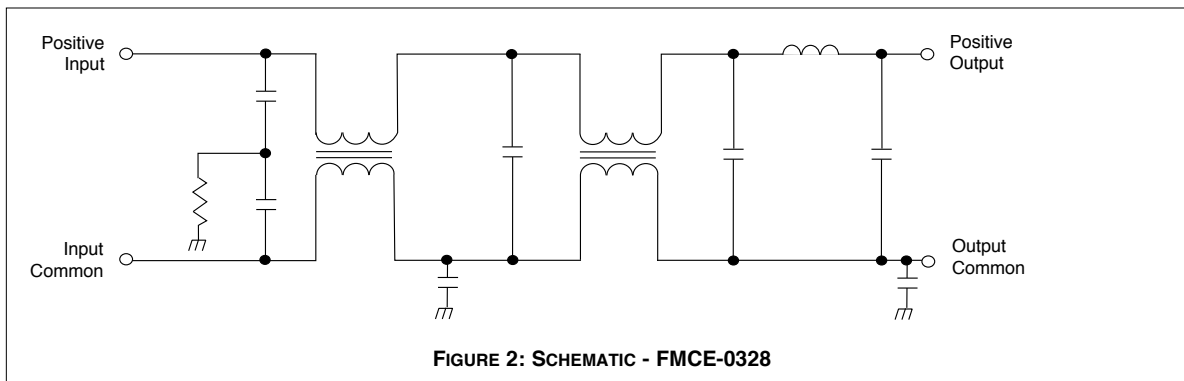
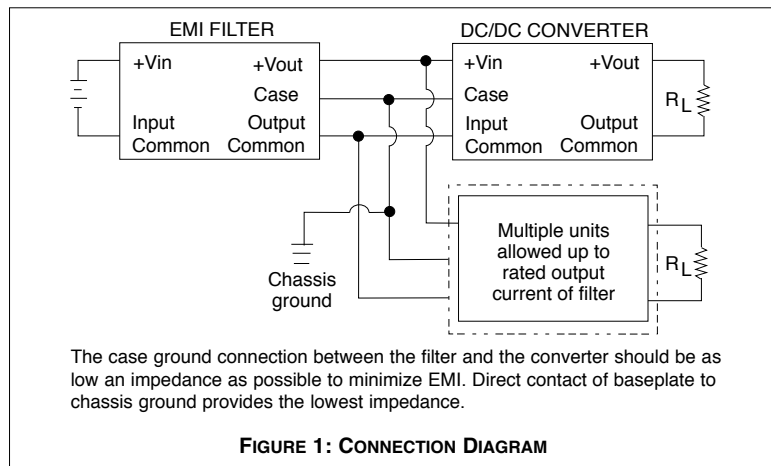

FMCE-0328 EMI Input Filter

28 VOLT INPUT – 3 AMP

PIN OUT	
Pin 1	Designation
1	Positive Input
2	Positive Output
3	Case Ground
4	Output Common
5	Input Common

Notes
1. All pins must be connected.

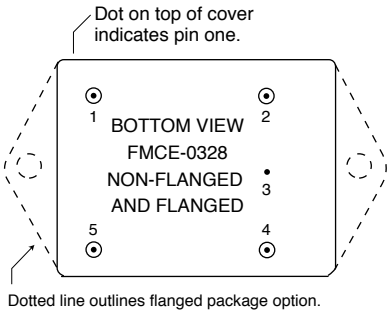

See cases E3 and G3 for dimensions.

FIGURE 3: PIN OUT

FMCE-0328 EMI Input Filter

28 VOLT INPUT – 3 AMP

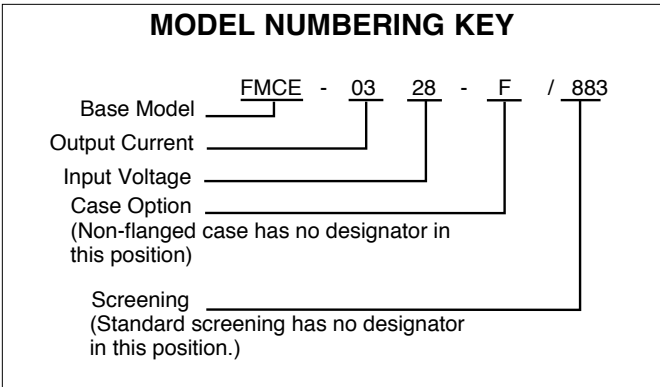

DSCC NUMBERS	
DSCC DRAWING (5915)	FME28 SIMILAR PART
IN PROCESS	FMCE-0328/883
IN PROCESS	FMCE-0328-F/883
1. Flanged SMDs have the suffix HZC instead of HXC. For exact specifications for a DSCC product, refer to the DSCC drawing. DSCC drawings can be downloaded from: http://www.dsccl.dla.mil/programs/smcr	

MODEL SELECTION			
ON THE LINES BELOW, ENTER ONE SELECTION FROM UNDER EACH CATEGORY TO DETERMINE THE MODEL NUMBER.			
CATEGORY	FMCE-0328 BASE MODEL AND INPUT VOLTAGE	– _____ CASE OPTION ¹	/ _____ SCREENING ²
SELECTION	“FMCE-0328” is the only available selection	(NON-FLANGED leave blank) F (FLANGED)	Standard (leave blank) ES 883 (Class H, QML)
1. Case Options: For the standard case, case E3, leave the case option blank. For the flanged case option, case G3, insert the letter F in the Case Option position. 2. Screening: For standard screening leave the screening option blank. For other screening options, insert the desired screening level. For more information see Screening Tables 1 and 2.			

FMCE-0328 EMI Input Filter

28 VOLT INPUT – 3 AMP

Electrical Characteristics: -55°C to +125°C T_C , nominal V_{in} , unless otherwise specified.

MODEL		FMCE-0328			UNITS
PARAMETER	CONDITIONS	MIN	TYP	MAX	
INPUT VOLTAGE	CONTINUOUS	-0.5	28	50	VDC
	TRANSIENT 1 sec ^{1, 2}	-0.5	—	80	V
NOISE REJECTION	500 kHz	50	60	—	dB
	1 MHz	55	60	—	
DC RESISTANCE (R_{DC}) AT MAXIMUM CURRENT	25°C	—	0.170	0.200	Ω
	$T_C = -55$ AND $+125^\circ\text{C}$ ¹	—	0.200	0.250	
CAPACITANCE	ANY PIN TO CASE $T_C = 25^\circ\text{C}$	—	22,000	24,000	pF
OUTPUT VOLTAGE ³	STEADY STATE	$V_{OUT} = V_{IN} - I_{IN} (R_{DC})$			VDC
OUTPUT CURRENT	STEADY STATE $V_{IN} = -0.5 - 50$ V	—	—	3	A
POWER DISSIPATION AT MAXIMUM CURRENT ¹	$T_C = 25^\circ\text{C}$	—	1.5	1.8	W
	$T_C = 125^\circ\text{C}$	—	—	2.25	

Notes

1. **Guaranteed by design, not tested.**
2. 0.5 ohm source impedance.
3. Typical applications result in V_{out} within 2% of V_{in} .

FMCE-0328 EMI Input Filter

28 VOLT INPUT – 3 AMP

Typical Performance Curves: 25°C T_C, nominal Vin, unless otherwise specified.

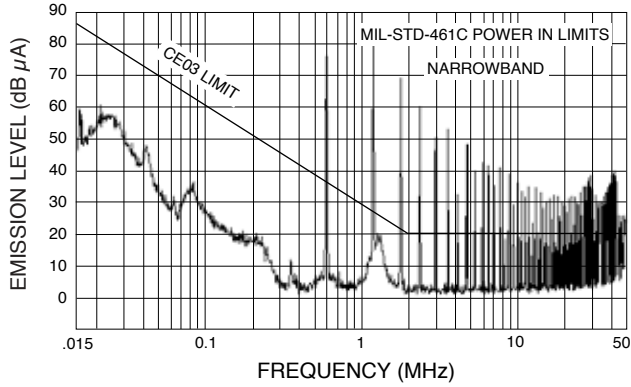

High power DC/DC converter without filtering.

FIGURE 4

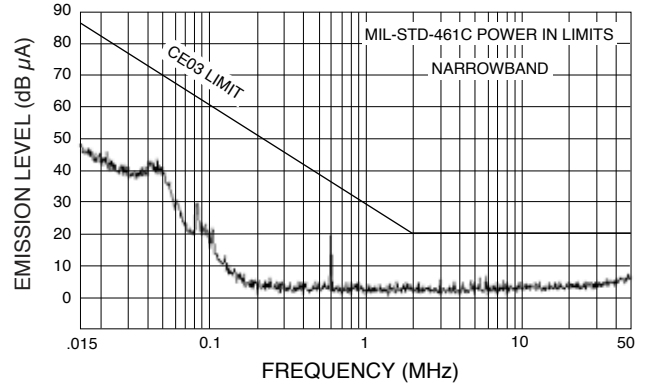

CE03: High power DC/DC converter filtered with an FMCE-0328

FIGURE 5

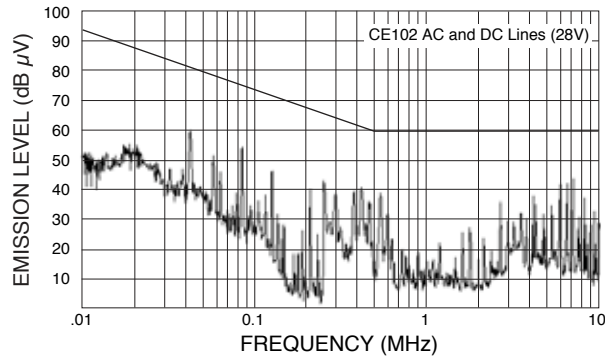

CE102: MFLHP2805S DC/DC converter filtered with an FMCE-0328.

FIGURE 6

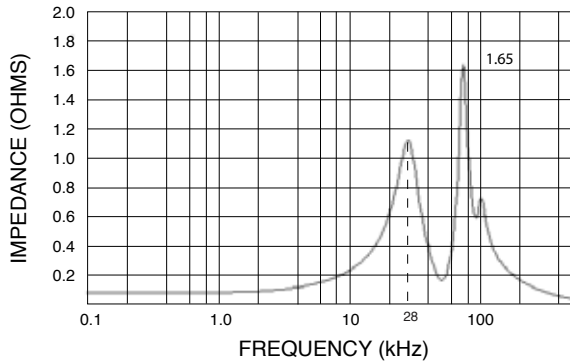

FMCE-0328 Output Impedance (measured at the output with input pins shorted)

FIGURE 7

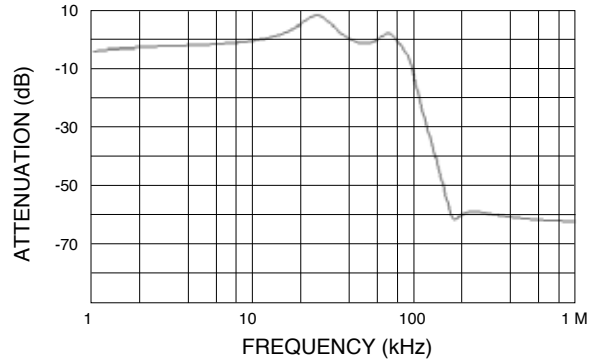

FMCE-0328 Attenuation

FIGURE 8

FMCE-0328 EMI Input Filter

28 VOLT INPUT – 3 AMP

BOTTOM VIEW CASE E3

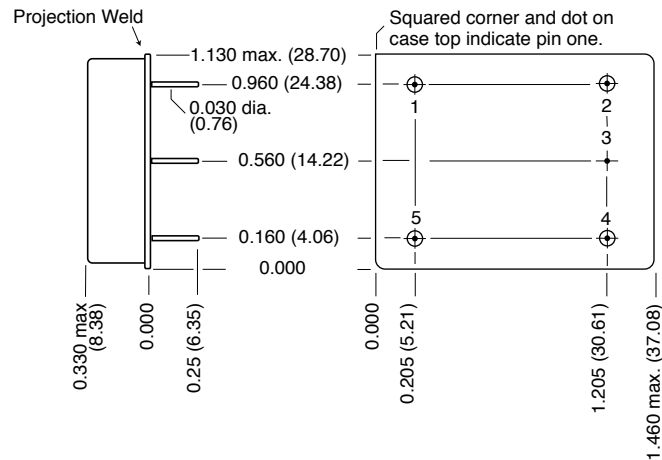

Case dimensions in inches (mm)

Tolerance ± 0.005 (0.13) for three decimal places
 ± 0.01 (0.3) for two decimal places
 unless otherwise specified

CAUTION

Heat from reflow or wave soldering may damage the device. Solder pins individually with heat application not exceeding 300°C for 10 seconds per pin.

Materials

Header Cold Rolled Steel/Nickel/Gold
 Cover Kovar/Nickel
 Pins #52 alloy/Gold compression glass seal.
 Seal Hole: 0.080 ± 0.002 (2.03 ± 0.05)

Case E3, Rev C, 20091105

Please refer to the numerical dimensions for accuracy. All information is believed to be accurate, but no responsibility is assumed for errors or omissions. Interpoint reserves the right to make changes in products or specifications without notice.
 Copyright © 1999-2009 Interpoint Corp. All rights reserved.

FIGURE 9: CASE E3

FMCE-0328 EMI Input Filter

28 VOLT INPUT – 3 AMP

BOTTOM VIEW CASE G3

Flanged cases: Designator "F" required in Case Option position of model number

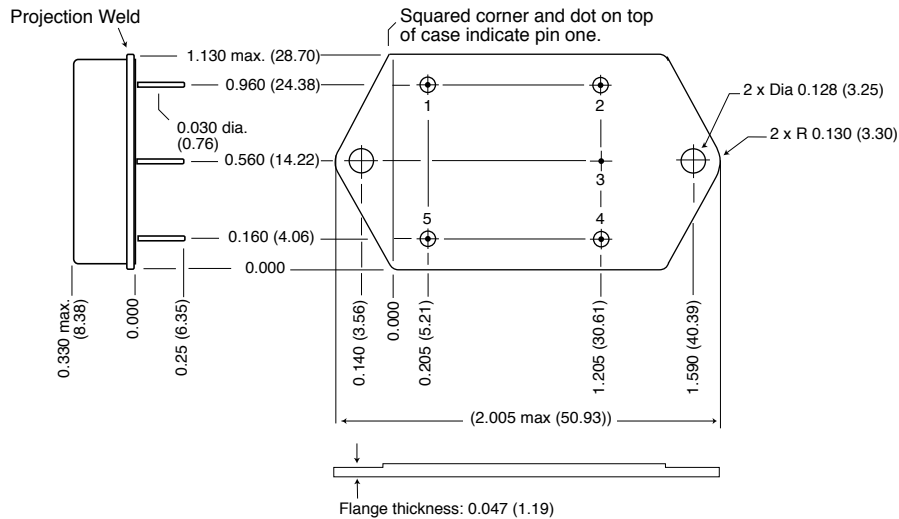

Case dimensions in inches (mm)

Tolerance ± 0.005 (0.13) for three decimal places
 ± 0.01 (0.3) for two decimal places
 unless otherwise specified

CAUTION

Heat from reflow or wave soldering may damage the device. Solder pins individually with heat application not exceeding 300°C for 10 seconds per pin.

Materials

Header Cold Rolled Steel/Nickel/Gold
 Cover Kovar/Nickel
 Pins #52 alloy/Gold compression glass seal.
 Seal Hole: 0.080 \pm 0.002 (2.03 \pm 0.05)

Case G3, Rev C, 20091105

Please refer to the numerical dimensions for accuracy. All information is believed to be accurate, but no responsibility is assumed for errors or omissions. Interpoint reserves the right to make changes in products or specifications without notice. Copyright © 1999-2009 Interpoint Corp. All rights reserved.

FIGURE 10: CASE G3

FMCE-0328 EMI Input Filter

28 VOLT INPUT – 3 AMP

STANDARD AND /ES (NON-QML) AND /883 (CLASS H, QML) PRODUCT ELEMENT EVALUATION

COMPONENT-LEVEL TEST PERFORMED	STANDARD AND /ES NON-QML ¹		/883 CLASS H QML	
	M/S ²	P ³	M/S ²	P ³
Element Electrical (probe)	yes	no	yes	yes
Element Visual	no	no	yes	yes
Internal Visual	no	N/A	yes	N/A
Final Electrical	no	no	yes	yes
Wire Bond Evaluation ⁴	no	no	yes	yes
SLAM™/C-SAM: Input capacitors only (Add'l test, not req. by H)	no	no	no	yes

Notes:

- Standard and /ES, non-QML products, do not meet all of the requirements of MIL-PRF-38534.
- M/S = Active components (Microcircuit and Semiconductor Die)
- P = Passive components
- Not applicable to EMI filters that have no wire bonds.

Definitions:

Element Evaluation: Component testing/screening per MIL-STD-883 as determined by MIL-PRF-38534
 SLAM™: Scanning Laser Acoustic Microscopy
 C-SAM: C - Mode Scanning Acoustic Microscopy

SCREENING TABLE 1: ELEMENT EVALUATION

FMCE-0328 EMI Input Filter

28 VOLT INPUT – 3 AMP

STANDARD AND /ES (NON-QML) AND /883 (CLASS H, QML) PRODUCT ENVIRONMENTAL SCREENING

TEST PERFORMED	125°C STANDARD NON-QML ¹	125°C /ES NON-QML ¹	/883 CLASS H QML
Pre-cap Inspection Method 2017, 2032	yes	yes	yes
Temperature Cycle (10 times) Method 1010, Cond. C, -65°C to 150°C, ambient Method 1010, Cond. B, -55°C to 125°C, ambient	no no	no yes	yes no
Constant Acceleration Method 2001, 3000 g Method 2001, 500 g	no no	no yes	yes no
Burn-in ² Method 1015, 125°C case, typical 96 hours 160 hours	no no	yes no	no yes
Final Electrical Test MIL-PRF-38534, Group A Subgroups 1 through 6: -55°C, +25°C, +125°C case Subgroups 1 and 4: +25°C case	no yes	no yes	yes no
Hermeticity Test Fine Leak, Method 1014, Cond. A Gross Leak, Method 1014, Cond. C Gross Leak, Dip (1 x 10 ⁻³)	no no yes	yes yes no	yes yes no
Final visual inspection Method 2009	yes	yes	yes

Test methods are referenced to MIL-STD-883 as determined by MIL-PRF-38534.

Notes:

- Standard and /ES, non-QML products, do not meet all of the requirements of MIL-PRF-38534.
- Burn-in temperature designed to bring the case temperature to +125°C

SCREENING TABLE 2: ENVIRONMENTAL SCREENING